

PETROL BLOWER

RAC52BPB-2

USER GUIDE

CAUTION: Read the instructions before using the machine!

CONTENTS

1. SAFETY INSTRUCTIONS.....	3
2. DESCRIPTION.....	7
3. ASSEMBLY.....	8
4. FUELLING AND LUBRICATION.....	8
5. STARTING/STOPPING THE MACHINE.....	9
6. MAINTENANCE	11
7. SPECIFICATIONS.....	12
8. DECLARATION OF CONFORMITY.....	13
9. WARRANTY.....	14
10. PRODUCT FAILURE.....	15
11. WARRANTY EXCLUSIONS.....	16

1. SAFETY INSTRUCTIONS

WARNING: For your own safety, please read this manual before attempting to operate your new unit. Failure to follow instructions can result in serious personal injury. Spend a few moments to familiarize yourself with your blower before each use. If you give this tool to another person, also hand over this manual.

Use this tool as described in this manual. Any mishandling and any use contrary to the instructions will not in any way engage the liability of the manufacturer.

Non-compliance with safety instructions and use can cause a risk of electric shock, fire and /or injury to persons.

READ YOUR USER MANUAL THOROUGHLY BEFORE OPERATING YOUR UNIT.

- This appliance is not intended for use by persons (including children) with reduced physical, sensory or mental capabilities, or lack of experience and knowledge, unless they have been given supervision or instruction concerning use of the appliance by a person responsible for their safety.
- Children should be supervised to ensure that they do not play with the appliance.
- Never allow children, persons with reduced physical, sensory or mental capabilities or lack of experience and knowledge or people unfamiliar with these instructions to use the machine, local regulations may restrict the age of the operator.
- Never use the machine when people, especially children, or pets are nearby.
- Remember that the operator or user is responsible for accidents or hazards occurring to persons or their belongings.
- Do not disassemble the tool yourself. Disassembly, repair or verification must be made exclusively by qualified personnel.
- WEAR CLOSE FITTING, TOUGH WORK CLOTHING that will provide protection, such as long slacks or trousers, safety work shoes, heavy duty work gloves, hard hat, a safety face shield, or safety glasses for eye protection. The tool is extremely noisy and requires the use of ear protection, such as a good grade of ear plugs or other sound barriers.
- Always carry the machine by its handle; never use any other part of the machine.
- REFUEL IN A SAFE PLACE. Open fuel cap slowly to release any pressure which may have formed in fuel tank. Always wipe unit of fuel or oil spills before starting. To prevent a fire hazard, move at least 10 feet (3meters) from fueling area before starting.
- TURN UNIT OFF before setting it down and also before installing or removing attachments.
- KEEP ALL SCREWS AND FASTENERS TIGHT and the unit in good operating condition. Never operate this equipment if it is improperly adjusted or not completely and securely assembled.
- KEEP HANDLES DRY, clean and free of fuel mixture.
- STORE EQUIPMENT AWAY FROM POSSIBLE IGNITION SOURCES, such as gas-powered water heaters, clothes dryers, or oil-fired furnaces, portable heaters, etc.
- ALWAYS KEEP the engine free of debris build-up.
- OPERATION OF EQUIPMENT should always be restricted to mature and properly instructed individuals.
- ALL PERSONS WITH RESPIRATORY PROBLEMS and persons operating blower in very dusty environments, should wear a dust particle mask at all times. Paper dust masks are available at most paint and hardware stores.
- Operate the machine only at reasonable hours - not early in the morning or late at night when people might be disturbed. Comply with times listed in local ordinances.

- Avoid using the machine in bad weather, especially when there is a risk of thunderstorms and lightning.
- In case of accident, immediately stop using the machine. Turn the machine off and check the problem. Do not use the machine while the machine is damaged.
- If the machine should start making any unusual noise or vibration, immediately shut off the power source and allow the machine to stop. Take the following steps before restarting and operating the machine:
 - a) Inspect for damage;
 - b) Replace or repair any damaged parts;
 - c) Check for and tighten any loose parts.
- If the machine becomes clogged, shut-off the power source before cleaning debris.
- Never operate the machine with defective guards or shields, or without safety devices in place.
- Keep the power source clean of debris and other accumulations to prevent damage to the power source or possible fire.
- Do not carry this machine while it is in operation. Always switch off the tool and always transport it by its handle and in order to avoid accidents and a fuel leak.
- Stop the machine and make sure that all moving parts have come to a complete stop
 - a) Whenever you leave the machine;
 - b) Before clearing blockages or unclogging chute;
 - c) Before checking, cleaning or working on the machine.
 - Do not tilt the machine while the power source is running.
- Operate the machine at the lowest possible engine speed to do the job. Like this, vibration and noise levels as well as the tool's wear can be kept to a minimum.
- Use rakes and brooms to loosen debris before blowing.
- In dusty conditions, slightly dampen surfaces.
- Use the full blower nozzle extension so the air stream can work close to the ground.
- Watch out for children, pets, open windows etc. and blow debris safely away.

WARNING: DO NOT USE ANY OTHER FUEL than that recommended in your manual. Always follow instructions in the Fuel and Lubrication section of this manual. Never use gasoline unless it is properly mixed with 2-cycle engine lubricant. Permanent damage to engine will result, voiding manufacturer's warranty.

- DO NOT SMOKE while refueling or operating equipment.
- DO NOT OPERATE UNIT WITHOUT A MUFFLER and properly installed muffler shield.
- DO NOT TOUCH or let your hands or body come in contact with a hot muffler or spark plug wire.
- DUE TO THE DANGER of exhaust fumes, never operate blower in a confined or poorly ventilated area.
- NEVER POINT BLOWER in the direction of people, animals, buildings, automobiles, or open windows, etc.
- DO NOT operate unit without inlet cover installed to prevent contact with impeller.
- DO NOT set a hot engine down where flammable material is present.
- DO NOT OPERATE UNIT FOR PROLONGED PERIODS. Rest periodically to prevent damage from vibration, damage to ears or damage to the appliance.
- Operate the machine in a recommended position and only on a firm, level surface.
- Do not operate the machine on a paved or gravel surface where ejected material could cause injury.

WARNING: DO NOT ADD, REMOVE OR ALTER ANY COMPONENTS OF THIS PRODUCT. Doing so could cause personal injury and/or damage the unit, voiding the manufacturer's warranty.

- DO NOT OPERATE UNIT WHILE TIRED, SICK OR UNDER THE INFLUENCE OF ALCOHOL OR DRUGS.
- DO NOT operate your unit near or around flammable liquids or gases whether in or out of doors. An explosion and/or fire may result.
- DO NOT WEAR loose clothing, scarfs, neck chains, unconfined long hair, and the like. Doing so could cause injury associated with objects being drawn into the rotating parts.
- DO NOT refuel a running engine or an engine that is hot.
- Before using, always visually inspect to see that fasteners are secure, the housing is undamaged and that guards and screens are in place. Replace worn or damaged components in sets to preserve balance. Replace damaged or unreadable labels.
- Before starting the machine, make certain that the tube is empty.
- Keep your face and body away from the nozzle.
- Do not allow hands or any other part of the body or clothing inside the discharge chute or near any moving part.
- Keep proper balance and footing at all times. Do not overreach. Never stand at a higher level than the base of the machine when blowing material with it.
- Always stand clear of the discharge zone when operating this machine.
- To reduce the risk of hearing loss associated with sound level, hearing protection is required.
- To reduce the risk of injury associated with contacting rotating parts, stop the engine before installing or removing attachments. Do not operate without guard in place. Always disconnect the spark plug before performing maintenance or accessing any movable parts.
- Do not point the blower nozzle in the direction of people or pets.
- Never run the unit without the proper equipment attached. When used as a blower, always install the blower tubes.
- Operate the machine only at reasonable hours – not early in the morning or late at night when people might be disturbed;
- Do not to operate the machine near open windows.
- Use rakes and brooms to loosen debris before blowing
- Slightly dampen surfaces in dusty conditions or use mister attachment;
- Limit the time of use of the tool. Take a time of rest between 2 operations. Do not work earlier or later in the night. Do be exposed to noise and vibration for a prolonged time. Noise can bring damage to the ears.
- This machine is extremely noisy. Always wear a hearing protection when use the tool.
- In the event of accident or breakdown, stop to use the machine. Switch off the tool and wait until it completely stops. Check the problem. In case of blockage, clear the blockage carefully. In case of breakdown, bring the tool to an after sales service for inspection and reparation. Only use the tool when it is safely unblocked.
- Operate the machine only at reasonable hours – not early in the morning or late at night when people might be disturbed;
- **WARNING:** there is danger from rotating parts; do not enter in contact with them.

Maintenance and storage

When the machine is stopped for servicing, inspection, or storage, or to change an accessory, shut off the power source and make sure that all moving parts have come to a complete stop. Allow the machine to cool before making any inspections, adjustments, etc. Maintain the machine

with care and keep it clean.





- Store the machine in a dry place out of the reach of children.
- Always allow the machine to cool before storing.
- Replace worn or damaged parts for safety. Use only genuine replacement parts and accessories.
- Never attempt to override the interlocked feature of the guard.



Residuals risks

Even if you use this product in compliance with all safety requirements, potential risks of injury and damage remain. The following hazards may arise from the structure and design of this product. Always be vigilant when using this product, so you can recognize and manage the risks early. Rapid intervention can prevent serious injury and property damage. Turn off the tool if there are any malfunctions. Have it checked by a qualified professional and have repairs carried out, if necessary, before using it again.

- There are harmful health consequences resulting from the emission of vibrations if the product is used for long periods of time or not properly managed and properly maintained.
- There is risk of injury and property damage due to attachments or broken the sudden impact of hidden objects.
- Risk of injury to persons and property caused by flying objects.
- Prolonged use of this product exposes the operator to vibration and can produce so-called "white finger" disease. To reduce the risk, wear gloves and keep your hands warm.
- If any of the symptoms of "white finger syndrome" occur, seek immediate medical attention. Symptoms of the "white finger" include numbness, loss of sensitivity, tingling, tingling, and pain, loss of strength, color changes or skin condition. These symptoms usually appear on the fingers, hands or wrists. Risk increases at low temperatures.
- Inhalation of particles of material blown.
- Unattended projections.
- Contact with foreign objects.
- Contact with the tool in operation.
- Hearing loss in the absence of correct hearing protection.

Symbols

	Read instruction handbook.
	Risk of projection, keep bystanders away.
	Wear ocular protection and hearing protection.
	Guarantee sound power level.

	Risk of fire.
	Hot surface.
	Risk of inhalation of exhausted gas.

Intended use

- This blower is meant to be used for blowing leaves, dust or garden debris into a desired direction. It must not be used for blowing water, chemical products, flammable material, metal or wood and other dangerous objects.
- This product is intended for private domestic use only. It must be used outdoors.
- This product is not intended to be used in a closed room and places where exhausted gas and flames can be present.
- The use of this product in case of rain or humid environments is prohibited.
- Any other use might lead to damage of the appliance, property or personal injury.

2. DESCRIPTION

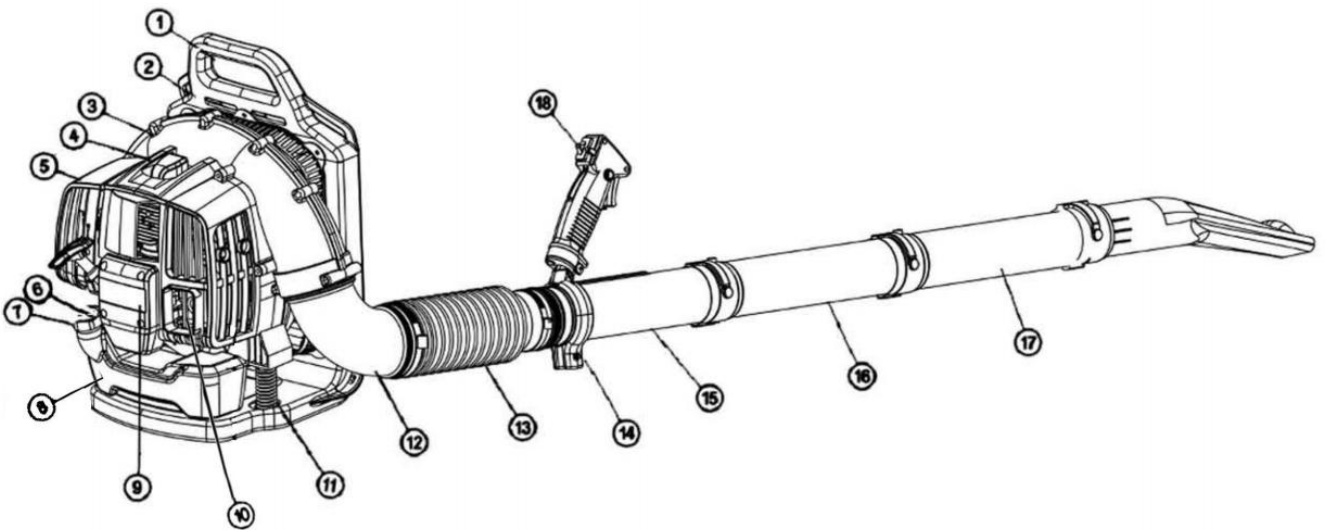

- | | |
|--------------------|------------------------|
| 1. Frame carrier | 10. Muffler |
| 2. Side cover | 11. Shock absorber |
| 3. Wind cover | 12. Flex connector |
| 4. Spark plug cap | 13. Bellows |
| 5. Gasoline engine | 14. Switch fixing seat |
| 6. Starter handle | 15. No.1 wind pipe |
| 7. Fuel tank cap | 16. No.2 wind pipe |
| 8. Fuel tank | 17. No.3 wind pipe |
| 9. Easy starter | 18. Switch |

3. ASSEMBLY

1. Assemble straight pipe with swivel to the pipe (13).
2. Assemble flexible pipe (13) to elbow (12) on blower.
3. Assemble clamps (A1 and B) onto both extremities and tighten.
4. Loosen wing nut(C) completely, install stick handle clamp (D).
5. Align notches (E) in handle clamp; stick handle should be angled away from operator.
6. Slide the stick handle onto pipe (14).
7. Position the stick handle for comfortable operation and tighten wing nut(C).
8. Assemble the pipe (17) to the straight pipe (16), turning straight pipe clockwise to lock in place.
9. Assemble straight pipe (16) to straight pipe (15) tightly.
10. Use a white nylon cable to tie the long cable to clamp A1.

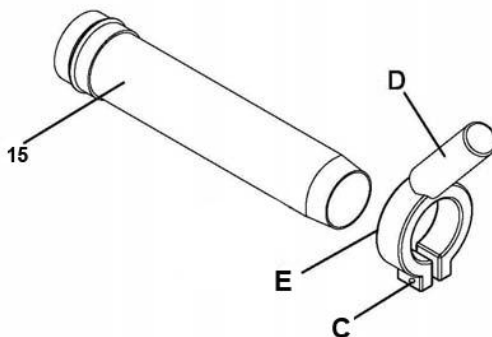
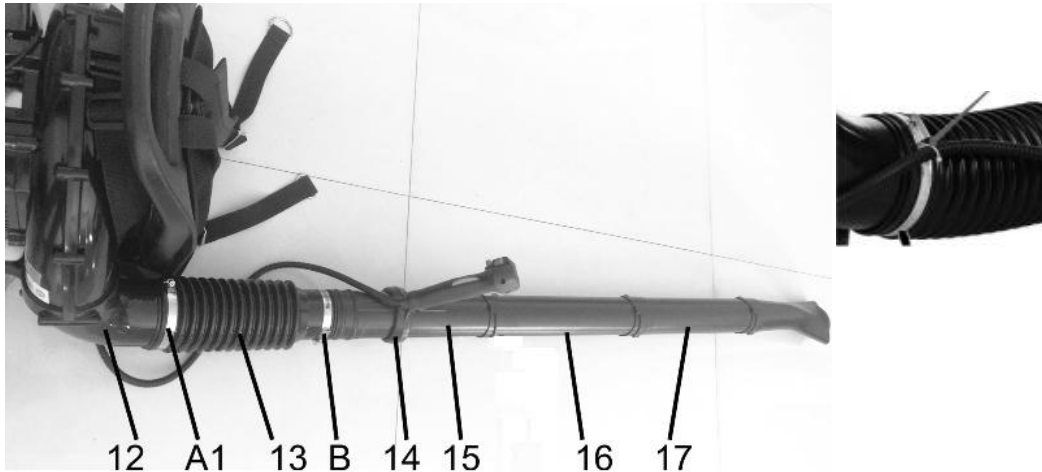

Adjusting backpack and harness and control handle

1. Place blower on your back by slipping arms through the shoulder straps as if you were putting on a backpack.
2. Once adjustments have been made to the straps for user comfort, remove the blower from your back and place on level ground in an upright position.
3. Adjust backpack harness and control handle.

4. FUELLING AND LUBRICATION

Fuel

Use a mixture of unleaded gasoline and 2-stroke engine oil for best results.

WARNING: Do not pour gasoline directly into the machine. This will cause irreversible damage to the engine and will void the warranty. Do not use a fuel mixture that has been stored for more than 90 days.

Oil / fuel mixture

First put oil in an approved container. Then add gasoline, and shake the container to get a full mix. The oil / fuel ratio must be 40: 1

Refueling

Open the fuel tank by removing its cap. Gently pour the fuel. Wipe off any overflow. Then close the tank.

Precautions for fueling

- Always use extreme care when handling fuel! Fuel is highly flammable.
- Never attempt to fuel the blower if the fuel system components are damaged or are leaking.
- Never attempt to refuel the engine while it is running or still warm, allow it to cool before fueling.
- Never smoke or light any fires near the blower or fuels.
- Always transport and store fuels in an approved container.
- Never place flammable material close to the engine muffler.
- Never operate the blower without a properly functioning muffler and spark arrestor installed.
- Never operate the blower unless it is properly assembled and in good working condition.
- Do not use petrol which contains ethanol or methanol as it may damage the fuel lines and other engine parts.
- Mix only enough fuel for your immediate needs. If fuel must be stored longer than 30 days, it should first be treated with a stabilizer or similar product.

5. STARTING/STOPPING THE MACHINE

Cold start

1. Turn the switch to position I.
2. Move the choke lever to the CLOSE position (B).
3. Pump the fuel by pressing the priming pump (C) 10 times.
4. Pull the starter grip 4-6 times, until the engine starts (D).
5. Move the choke lever to OPEN position (E).
6. Press the lock button and then the trigger (F) to start the operation.

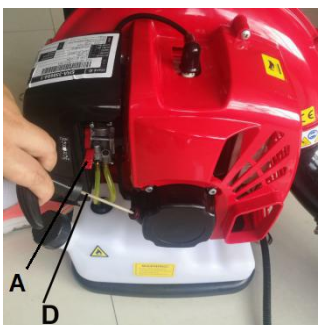
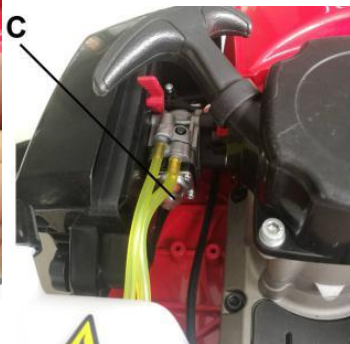

HOT STARTING

1. Move throttle lever (A) to idle detent position move the stop switch to "I" position
2. Then push the throttle level on the OPEN position.
3. Pull recoil starter handle and engine should start.

STOPPING ENGINE

Release the joystick, let the machine idle. Then press the switch to stop the machine.

Blower operations

1. Use the blower for trees, shrubs, flower beds, and hard-to-clean areas.
2. Use the unit around buildings and for other normal cleaning procedures.
3. Use the blower around walls, overhangs, fences, and screens.

WARNING: Because of flying debris, always use approved shielded safety glasses or a face operating the blower

WARNING: DO NOT operate the blower with other people or animals in the immediate shield when vicinity. Allow a minimum of 50 feet (15 meters) between operator and other people or animals.

WARNING: Before using your blower, review the safety Instructions in your user manual, and all regulations for operation of the unit. These precautions and regulations are for your protection.

4. We recommend that a face mask be worn when operating the blower in dusty areas.
5. Stand away from the debris, at a distance that will easily allow you to control the direction of blown debris. Never blow debris in direction of bystanders.
6. To control velocity of air stream, blower can be operated at any speed between idle and full throttle. Experience with the unit will help you determine the amount of airflow necessary for each application.
7. To reduce sound levels, limit the number of pieces of equipment used at any one time.
8. Check your equipment before operation, especially the muffler, air intakes and air filters.
9. Use rakes and brooms to loosen debris before blowing. In dusty conditions, slightly dampen surfaces when water is available.
10. Conserve water by using power blowers instead of hoses for many lawn and garden applications, including areas such as gutters, screens, patios, grills, porches and gardens.
11. Use intermediate tube plus nozzle of your choice so the air stream can work close to the ground.
12. After using blowers and other equipment, CLEAN UP! Dispose of debris in trash receptacles.

Operating instructions

1. Follow the instructions "STARTING A COLD ENGINE".
2. Once unit is running, place unit on your back by slipping arms through the shoulder straps as if you were putting on a backpack.
3. When preparing to clear an area of debris, always position yourself so that you can control the direction debris will be blown.
4. The control handle and the flexibility of the blower tube assembly will allow you to clear the most hard-to-reach areas.
5. The hand grip, throttle trigger, lock-out button and on/off ignition switch are all mounted on a swivel handle that offers a wide range of operating positions and comfort.

6. MAINTENANCE

Cleaning the Air Filter

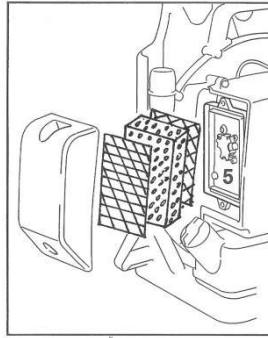
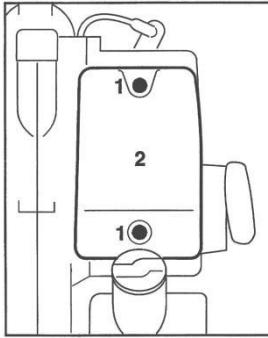

Dirty air filters reduce engine power increase fuel consumption and make starting more difficult.

- Turn choke knob to 
- Release the screws (1) and pull off the filter cover (2).
- Remove the filter from the cover and inspect it - if it is dirty or damaged, clean the filter or fit a new one.
- Install the main filter and prefilter elements in the filter cover.
- Fit the cover on the filter base and tighten it down firmly.

Carburetor

General information

Your carburetor comes from the factory with a standard setting. This setting provides an optimum fuel-air mixture under most operating conditions.

The high-speed screw alters the engine's power output and the maximum off-load engine speed.

If the setting is too lean there is a risk of engine damage due to insufficient lubrication and overheating.

A modification of the carburetor adjustment must be made by a qualified after-sales service.



Checking the Spark Plug

If engine is down on power, difficult to start or runs poorly at idle speed first check the spark plug.

- Remove the spark plug - see "Starting / Stopping the Engine"
- Check electrode gap (A) and readjust if necessary – see "Specifications".



Storing the Machine

For periods of about 3 months or longer

- Drain and clean the fuel tank in a well-ventilated area.
- Run engine until carburetor is dry - this helps prevent carburetor diaphragms sticking together.
- Thoroughly clean the machine- pay special attention to the cylinder fins and air filter.
- Store the machine in a dry, high or locked location - out of the reach of children and other unauthorized persons.
- Do not expose the container to direct sunlight for unnecessarily long periods. UV rays can make the container material brittle, which could result in leaks or breakage.

7. SPECIFICATIONS

Model	RAC52BPB-2
Engine	1E44F-5 Air cooled, two-stroke, single cylinder gasoline
Displacement	52cm ³
Rated power	1,45 kW
Idle Speed	3000/min
Max speed	7500/min
Air volume	890m ³ /h
Air speed.	78m/s
Fuel	Mixed (Gasoline and Two-stroke Oil)
Oil	40:1 High Performance, two-stroke air
Carburetor	Diaphragm
Ignition System	Flywheel Magneto, capacitor discharge
Spark plug	L7RTC Gap (0.6~0.7) mm
Exhaust System	Spark Arrestor Muffler
Length*Width*Height	1870mm*440mm*505mm
Net Weight	Max. 9.6kg
Measured sound pressure level	LpA: 98.5 dB(A) K= 3.0 dB(A)
Measured sound power level	LwA: 108.3 dB(A) K=3.0 dB(A)
Guarantee sound power level	116 dB(A)
Vibration value	Max. 4,194 m/s ² K=1,5 m/s ²

8. DECLARATION OF CONFORMITY



BUILDER SAS

32 rue Aristide Bergès - Z.I. du Casque - 31270 Cugnaux - France

Tel: +33 (0)5.34.502.502 Fax: +33 (0)5.34.502.503

Declares that the machines:

PETROL BLOWER

Model: RAC52BPB-2

Serial No.: 20230905271-20230905470

The people name holding the technical file: M. Olivier Patriarca

Have been designed in compliance with the following standards:

EN15503:2009/A2:2015

EN ISO14982:2009

And in accordance with the following directives:

Directive Machine 2006/42/EC

EMC directive 2014/30/EU

Emission directive (EU) 2016/1628 & 2018/989/EU

Noise directive 2000/14/CE Annexe V & Directive 2005/88/CE

Measured sound power level: 108.3dB(A) K=3.0 dB(A)

Guaranteed sound power level: 116dB(A)

Cugnaux, 20/08/2023

A handwritten signature in black ink, appearing to read 'Philippe MARIE', is enclosed within a thin black rectangular border.

Philippe MARIE / PDG

9. WARRANTY



WARRANTY

The manufacturer guarantees the product against defects in material and workmanship for a period of 2 years from the date of the original purchase. The warranty only applies if the product is for household use. The warranty does not cover breakdowns due to normal wear and tear.

The manufacturer agrees to replace parts identified as defective by the designated distributor. The manufacturer does not accept responsibility for the replacement of the machine, in whole or in part, and/or ensuing damage.

The warranty does not cover breakdowns due to:

- insufficient maintenance.
- abnormal assembly, adjustment or operations of the product.
- parts subject to normal wear and tear.

The warranty does not extend to:

- shipping and packaging costs.
- using the tool for a purpose other than that for which it was designed.
- the use and maintenance of the machine done in a manner not described in the user manual.

Due to our policy of continuous product improvement, we reserve the right to alter or change specifications without notice. Consequently, the product may be different from the information contained therein, but a modification will be undertaken without notice if it is recognized as an improvement of the preceding characteristic.

READ THE MANUAL CAREFULLY BEFORE USING THE MACHINE.

When ordering spare parts, please indicate the part number or code, you can find this in the spare parts list in this manual. Keep the purchase receipt; without it, the warranty is invalid. To help you with your product, we invite you to contact us by phone or via our website:

- **+33 (0)9.70.75.30.30**
- **<https://services.swap-europe.com/contact>**

You must create a "ticket" via the web platform.

- Register or create your account.
- Indicate the reference of the tool.
- Choose the subject of your request.
- Describe your problem.
- Attach these files: invoice or sales receipt, photo of the identification plate (serial number), photo of the part you need (for example: pins on the transformer plug which are broken).



10. PRODUCT FAILURE

WHAT TO DO IF MY MACHINE BREAKS DOWN?

If you bought your product in a store:

- a) Empty the fuel tank if your product has one.
- b) Make sure that your machine is complete with all accessories supplied, and clean! If this is not the case, the repairer will refuse the machine.

Go to the store with the complete machine and with the receipt or invoice.

If you bought your product on a website:

- a) Empty the fuel tank if your product has one.
- b) Make sure that your machine is complete with all accessories supplied, and clean! If this is not the case, the repairer will refuse the machine.
- c) Create a SWAP-Europe service ticket on the site: <https://services.swap-europe.com> When making the request on SWAP-Europe, you must attach the invoice and the photo of the nameplate (serial number).
- d) Contact the repair station to make sure it is available before dropping off the machine.

Go to the repair station with the complete machine packed, accompanied by the purchase invoice and the station support sheet downloadable after the service request is completed on the SWAP-Europe site

For machines with engine failure from manufacturers BRIGGS & STRATTON, HONDA and RATO, please refer to the following instructions.

Repairs will be done by approved engine manufacturers of these manufacturers, see their site:

- <http://www.briggsandstratton.com/eu/fr>
- <http://www.honda-engines-eu.com/fr/service-network-page;jsessionid=5EE8456CF39CD572AA2AEEDFD290CDAE>
- <https://www.rato-europe.com/it/service-network>

Please keep your original packaging to allow for after-sales service returns or pack your machine with a similar cardboard box of the same dimensions.

For any question concerning our after-sales service you can make a request on our website <https://services.swap-europe.com>

Our hotline remains available at +33 (9) 70 75 30 30.



11. WARRANTY EXCLUSIONS

THE WARRANTY DOES NOT COVER:

- Start-up and setting up of the product.
- Damage resulting from normal wear and tear of the product.
- Damage resulting from improper use of the product.
- Damage resulting from assembly or start-up not in accordance with the user manual.
- Breakdowns related to carburetion beyond 90 days and fouling of carburetors.
- Periodic and standard maintenance events.
- Actions of modification and dismantling that directly void the warranty.
- Products whose original authentication marking (brand, serial number) has been degraded, altered or withdrawn.
- Replacement of consumables.
- The use of non-original parts.
- Breakage of parts following impacts or projections.
- Accessories breakdowns.
- Defects and their consequences linked to any external cause.
- Loss of components and loss due to insufficient screwing.
- Cutting components and any damage related to the loosening of parts.
- Overload or overheating.
- Poor power supply quality: faulty voltage, voltage error, etc.
- Damages resulting from the deprivation of enjoyment of the product during the time necessary for repairs and more generally the costs related to the immobilization of the product.
- The costs of a second opinion established by a third party following an estimate by a SWAP-Europe repair station
- The use of a product which would show a defect or a breakage which was not the subject of an immediate report and/or repair with the services of SWAP-Europe.
- Deterioration linked to transport and storage*.
- Launchers beyond 90 days.
- Oil, petrol, grease.
- Damages related to the use of non-compliant fuels or lubricants.

* In accordance with transport legislation, damage related to transport must be declared to carriers within 48 hours maximum after observation by registered letter with acknowledgement of receipt.

This document is a supplement to your notice, a non-exhaustive list.

Attention: all orders must be checked in the presence of the delivery person. In case of refusal by the delivery person, it you must simply refuse the delivery and notify your refusal.

Reminder: the reserves do not exclude the notification by registered letter with acknowledgement within 72 hours.

Information: Thermal devices must be wintered each season (service available on the SWAP-Europe site). Batteries must be charged before being stored.



BUILDER SAS
32 rue Aristide Bergès - Z.I. du Casque - 31270 Cugnaux - France
Made in PRC 2023